

# LPU- 40 Flotation Collar

## User's Manual



Aerial Machine and Tool Corp.  
4298 JEB Stuart Hwy  
Meadows of Dan, VA 24120



[www.aerialmachineandtool.com](http://www.aerialmachineandtool.com)  
Phone: 276-952-2006  
FAX: 276-952-2231

## List of Revisions or Amendments

Date	Revision or Amendment
12 January 2010	Addition of annual and funtional inspection procedures
29 March 2011	Correction of CO2 bottle size
26 March 2012	Correction to Green Plastic Safety Clip PN
26 March 2012	Address/Logo change

## Table of Contents

1. Introduction	4
2. Attaching the Collar to the Vest	5
3. Inflating the Bladder	8
4. Inspection	12
5. Maintenance	12
6. Storage	12
7. LPU-40 Flotation Collar Repack Instructions	13
8. Annual Inspection	20
9. Functional Inspection	21
Appendix A. LPU-40 Flotation Bladder Nomenclature	22
Appendix B. LPU-40 Casing Nomenclature	23
Appendix C. Bladder Evacuation Attachment Nomenclature	24
Appendix D. LPU-40 Bladder Folding Diagram	25
Appendix E. LPU-40 Folding Cinch Strap Diagram	26
Appendix F. LPU-40 Spare Parts List	27

## Copyright Notice

This owner's manual is copyrighted, all rights reserved. It may not, in whole or in part, be copied, photocopied, reproduced, translated or reduced to any electronic medium or machine readable form without prior consent in writing from Aerial Machine and Tool Corp.

Copyright © 2007 Aerial Machine & Tool Corp.

The following symbols are used throughout this manual:



**WARNINGS** indicate a procedure or situation that may result in serious injury or death if instructions are not followed correctly.



**CAUTIONS** indicate any situation or technique that will result in potential damage to the product, or render the product unsafe if instructions are not followed correctly.



**NOTES** are used to emphasize important points, tips, and reminders.

## 1. Introduction

The LPU-40 Flotation Collar is a flotation device designed to support air crewmen stranded in water. The collar is attached to the air crewman's flight vest. It provides a minimum of 65 pounds of flotation buoyancy and is designed to keep the user's head above the water for an extended period of time.

The LPU-40 is packed in a low profile casing made of fire resistant Nomex<sup>®</sup> that is designed to open when the dual-chambered bladder inflates. A single-pull beaded handle, when manually pulled, activates two 29-gram CO<sub>2</sub> gas cartridges for inflation. Two oral inflation tubes allow the user to manually increase, decrease, or maintain the air pressure in the bladder chambers.



The capacity of the CO<sub>2</sub> cartridges can range from 28 to 31 grams.

Your LPU-40 Flotation Collar is an important piece of survival equipment. Proper care and maintenance will ensure your vest will accomplish the level of safety performance it is designed for. It is important that you become familiar with these instructions to safely use this flotation collar.



### **WARNING**

KEEP YOUR FLOTATION COLLAR IN USABLE CONDITION. IMPROPER WEAR MAY RESULT IN DAMAGE TO THE COLLAR. DO NOT WEAR ANY GARMENT OR PIECE OF EQUIPMENT OVER THE COLLAR. IMPROPER USE OR NEGLIGENT CARE OF THIS EQUIPMENT CAN CAUSE SERIOUS INJURY OR DEATH.

## 2. Attaching the Collar to the Vest

### 2.1

The collar attaches to the vest with a MOLLE Strap system and has four attachment straps: two on the top of the collar, and two on the bottom.

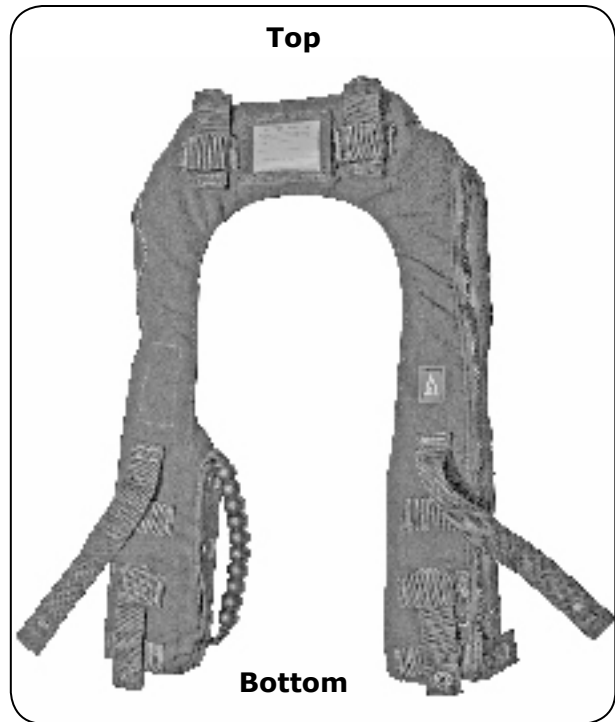

2.1 Attachment points.

### 2.2

The attachment points for the top of the collar are on the back of the vest.

The attachment points for the bottom of the collar are on the front of the vest at chest level.

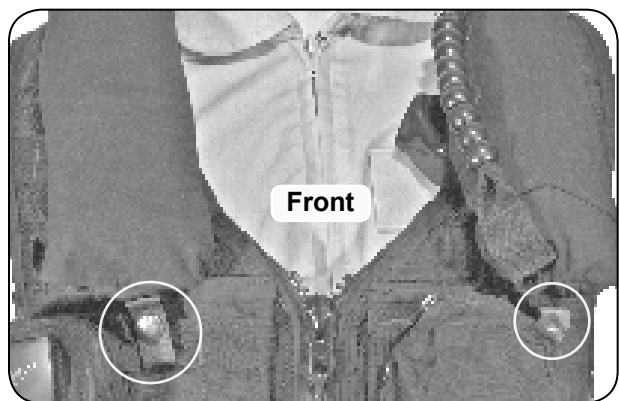
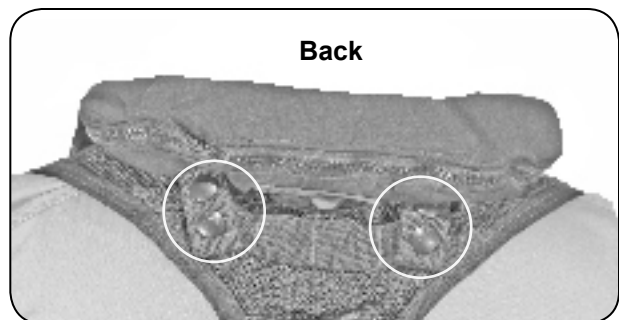

2.2 Attachment points.

### 2.3

Attach the top of the collar to the vest first.

Thread the MOLLE straps on the collar through the channeled webbing on the vest and secure the Pull-the-Dot fasteners.

Each strap has two Pull-the-Dot fasteners. Ensure that all four Pull-the-Dot fasteners are fastened.



2.3 Attaching the top.

### 2.4

The bottom attachment is threaded through four webbing straps on each side of the vest.

On each side of the vest, weave the MOLLE strap through the first two channels on the vest and collar.



2.4 Attaching the bottom.

2.5

Thread both the collar strap and the closing tab with the snap stud through the third channel on the vest, then through the last channel on the collar.



2.5 Threading the bottom channels.

2.6

Thread only the collar strap through the last vest channel.

Wrap the strap around the vest channel and secure the Pull-the-Dot fastener.

Tuck the end of the closing tab underneath the collar casing.

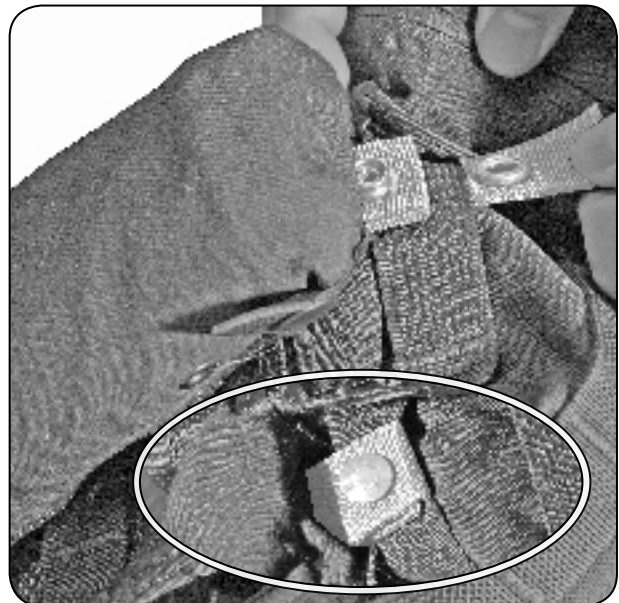

2.6 Closing the snap.

### 3. Inflating the Bladder

#### 3.1

Grab the beaded handle with either hand and forcefully pull down to release it from the cover flap.

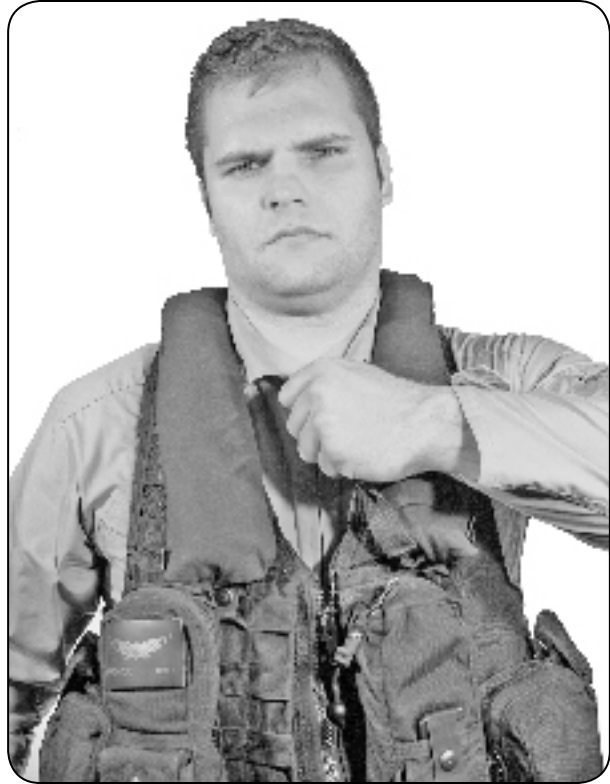

3.1 Grabbing the beaded handle.

#### 3.2

Continue to pull the handle forcefully in the down-and-out direction; apply constant pressure on the handle until the bladders begin to inflate.

Repeat this step if the bladder does not begin to inflate or if only one lobe inflates.



3.2 Activating the CO<sub>2</sub> gas.

3.3

The two lobes may be attached and anchored to your vest using the cinch ring located on the left-inside-bottom area of the vest. Anchoring the lobes to the vest improves the angle of flotation.



**CAUTION**

**Release the cinch ring prior to over-water missions.**



**WARNING**

IF YOU MUST DROP THE CINCH RING WHILE YOU ARE SUBMERGED IN WATER, DO NOT UNZIP YOUR VEST TO DO SO.

DROP THE CINCH RING BY REACHING UNDER YOUR VEST WHILE IT IS FULLY DONNED WITH THE SLIDE FASTENER UP.

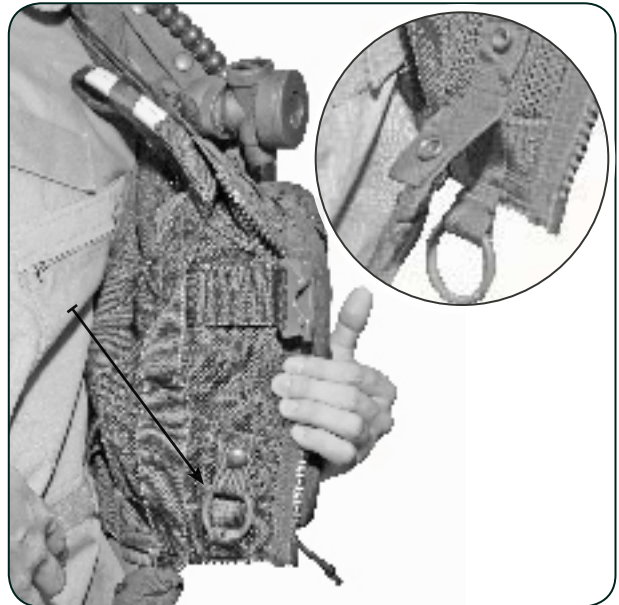

3.3 Exposing the cinch ring.

3.4

The right lobe has a cinch strap with a snap hook.

Remove the cover from the snap hook.



3.4 Anchor strap.

3.5

Route the cinch strap through the loop on the left lobe and attach the snap hook to the cinch ring.



3.5 Routing the strap.

3.6

Tighten the cinch strap by pulling on the free end until the flotation lobes are brought close together.



3.6 Adjusting the cinch strap.

## 3.7

The oral inflation tubes are on the right lobe. The valve has a rubber mouth piece and a knurled locking nut.

Temperature changes may effect the pressure in the bladder. Use oral inflation to increase or relieve pressure from the bladder.

Turn the knurled locking nut clockwise until it stops.

Push the valve in with your mouth and blow air into the bladder to increase the pressure.

Depress the valve to release pressure from the bladder.

Tighten the knurled locking nut by turning it counter clockwise when you are finished.



3.7 Oral inflation.

## 3.8

For improved angle of flotation, put your arms through the straps that run down the sides of the bladder until the lobes are tight against your body.



3.8 Arm placement.



**REMEMBER: Panic and fatigue cause drowning.**

**Stay calm and conserve your energy.**

## 4. Inspection

It is the responsibility of the air crewman to inspect the LPU-40 flotation collar before flight operations. Perform a preflight inspection prior to each flight and at intervals not to exceed 30 days. If damage is found during an inspection, the vest must be grounded until repaired.

1. Inspect the outside of the collar for:

- Cuts, tears, and abrasion damage
- Open seams and loose or broken stitching
- Contamination damage

2. Ensure that the entire length of the slide fastener is closed and there are no missing teeth.



**CAUTION:** DO NOT OPEN THE FLOTATION COLLAR SLIDE FASTENER FOR ROUTINE INSPECTION.

3. Ensure that the beaded inflation handle is attached with 3 snaps fastened.

4. Ensure that the flotation collar is attached to the vest and all of the attachment snaps are fastened.

## 5. Maintenance

Maintenance of the LPU-40 flotation collar consists of cleaning, service, and repair. The air crewman's responsibility for maintenance is limited to inspecting the outside components of the collar. Service and repairs shall be completed only by an authorized service station or the manufacturer. Remove the collar from the vest to wash the vest.

## 6. Storage

Store your LPU-40 Flotation Collar on a clothes hanger away from direct sunlight in a dry, well ventilated place. Do not store your collar near sources of heat such as a radiator, or in a warm humid environment where mold or mildew can contaminate the vest.

## 7. LPU-40 Flotation Collar Repack Instructions

### 7.1 Preparation

Repack the LPU-40 on a large flat surface big enough to accommodate the bladders when they are spread flat with no air in them. Orientation references the wearer's right and left.

The required tools are:

- Replacement CO<sub>2</sub> bottle, Mil-C-25369, 29 gram, 2 each.
- Slide Fastener (zipper) for closing the Nomex<sup>®</sup> case.
- Green safety clips, 2 each.
- Optional: clamps with soft rubber or plastic inserts to hold the bladder while packing.

7.1.1 Deflate the bladder by unlocking both oral tube valves. Depress the valves to release the pressure. While keeping the valves pressed in, gently compress the bladder with your hands and arms. This will force the air through the oral tubes.

7.1.2 Remove the flotation collar assembly from the vest and harness.

7.1.3 Lay the flotation collar flat on the table with the underside down. Ensure that the closing zipper is fully disengaged. Spread the Nomex<sup>®</sup> case open and completely lay out the bladder.

7.1.4 Remove and discard spent or punctured CO<sub>2</sub> cylinders.

7.1.5 Visually inspect the Nomex<sup>®</sup> case, inflatable bladder, and components of the flotation collar. Replace damaged bladder and/or components as necessary.

7.1.6

Place the actuator levers in the up-and-armed position. Install two new CO<sub>2</sub> cylinders (Mil-C-25369, 29 gram).

Hand tighten the cylinders (avoid over tightening). Install a green safety clip on both of the actuators.



7.1.6 Installing the green safety clips.

### 7.1.7

It is important that all the trapped air be removed to aid in the repack of the bladder assembly and to provide for a compact and low profile collar.

Remove trapped air by unlocking both oral tube valves and depressing them. A small electric vacuum pump used with the bladder evacuation hose adapter with dual holes (P/N: AMTC-M2026) may be used to aid in removal of the trapped air.

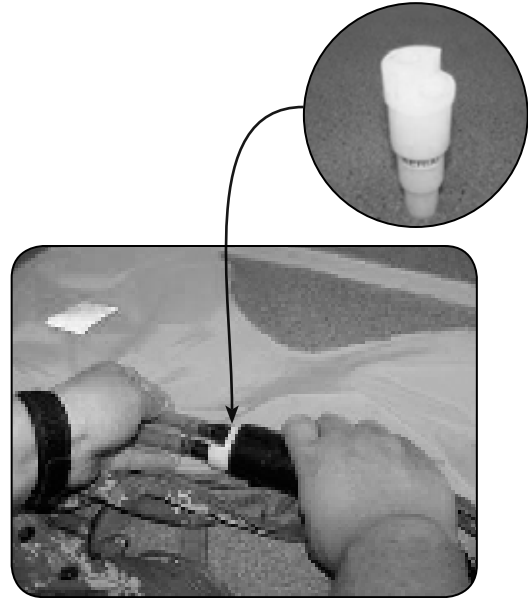

7.1.7 Removing the air from the bladders

7.1.8 Release and lock the oral inflation tubes in the closed and locked position.

## 7.2 Folding the Bladder

 Refer to Appendix D. for step-by-step illustrated drawings of Section 7.2: Folding the Bladder.

### 7.2.1

Lay the bladder out flat on the table.  
Position the actuators and the oral tubes facing up.

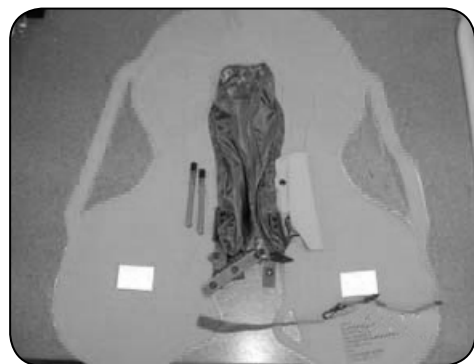

7.2.1 Preparing the bladder for folding.



Small shot bags or small plastic spring clamps will aid in maintaining the folds as you work on different areas of the bladder.

### 7.2.2

Fold the bottom of both the left and right lobes of the inflatable bladder under and along a horizontal line extending out from the bottom of the bladder attachment tabs.



7.2.2 Folding the bottom of the lobes.

### 7.2.3

Fold over the left lobes (the side with the CO<sub>2</sub> actuators) of the inflatable bladder towards the center of the assembly along a vertical line extending the length of the bladder. This fold should be up tight against the CO<sub>2</sub> actuators/cylinders (approximately 3" in width).



Continue to fold the remainder of the left lobe onto itself in accordion fashion. Align the edges of the folds with either the inner vertical edge of the bladder or with the outer edge of the previous fold.



7.2.3 Folding the left side.

When completed, there will be a total of three accordion-type folds that are 3" wide as measured along the left extension. Clamp the folds to hold them in place.

#### 7.2.4

Take the right lobes (the side with the oral inflation tubes) and make a fold toward the center of the assembly along a vertical line extending the length of the inflatable bladder. This fold should be approximately 3" in width from the inner edge of the bladder.

Continue to fold the remainder of the right lobe onto itself in accordion fashion. Align the edges of the folds with either the inner vertical edge of the bladder or with the outer edge of the previous fold.

When completed, there will be a total of three accordion-type folds that are 3" wide as measured along the left extension. Clamp the folds to hold them in place.

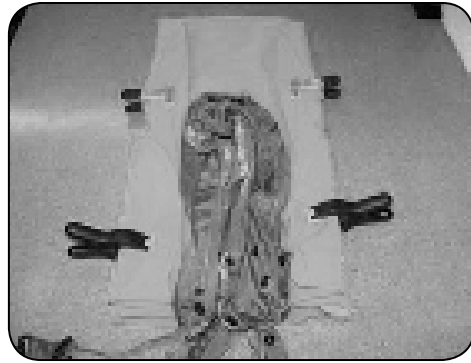

7.2.4 Folding the right side.

#### 7.2.5

Fold the top of the bladder next. From the top of the right extension, fold the bladder over and along a 45° angle from the horizontal.

Repeat the previous step for the opposite side (top left lobe).

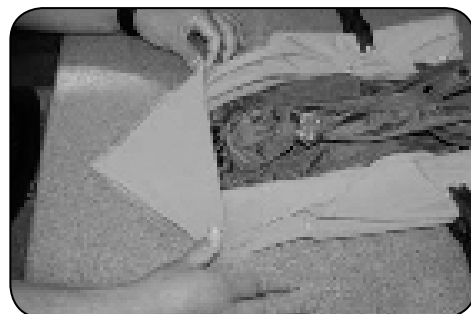

7.2.5 Folding the top.

7.2.6

Fold the top of the bladder under and along a horizontal line approximately 3” from the top of the neckline. Clamp the top folds to prevent undoing.



7.2.6 Folding the top.

**7.3 Packing the Bladder in the Nomex® Case**

7.3.1

Wrap the Nomex® case around the bladder.

Fold the bladder concealment tab over the bladder.



7.3.1 Packing the bladder.

7.3.2

Thread size “B” nylon safety thread through the safety stitch eyelets.

Install the slide fastener on the left-inner zipper cord and move the slider to the zipper retainer stop located at the bottom of the right extension.

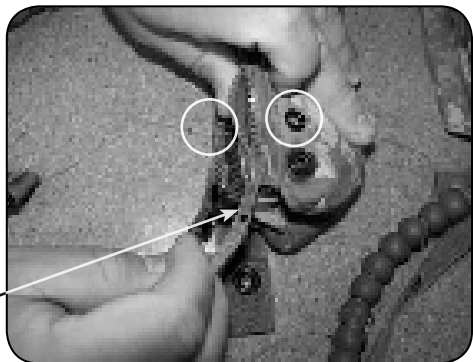

7.3.2 Installing the slide fastener.

 Ensure that the slider mates properly with the zipper retainer (i.e. flat to flat).

### 7.3.3

Starting from the bottom of the right side, tuck the first 6 inches of the folded bladder into place inside the case (remove and replace clamps as necessary).



7.3.3 Stowing the bladder.

### 7.3.4

Tie the safety stitch with a surgeon's knot plus one square knot.

Trim the tie 2 cm. above the knot.

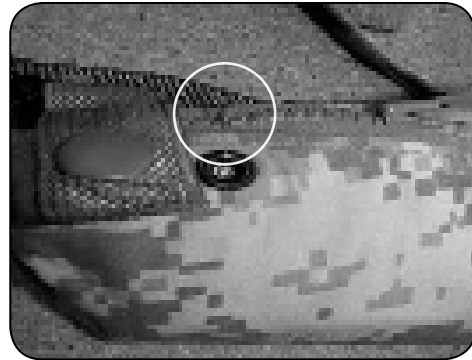

7.3.4 Tying the safety stitch.

### 7.3.5

Place the cinch strap hook into the separate sleeve cover. Fan fold the cinch strap and pack it in the under side of bladder.



Refer to Appendix E. for step-by-step illustrated drawings of folding the cinch strap.

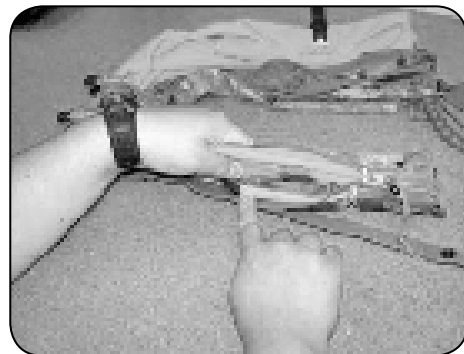

7.3.5 Stowing the cinch strap.

## 7.3.6

Continue to tuck the bladder and close the case with the zipper until the entire bladder has been secured.

Tie the safety stitch and remove the zipper slider from the casing.



Fine tuning the folds may be required to obtain a proper fit.



7.3.6 Closing the Nomex<sup>®</sup> case.

## 7.3.7

Snap the tab fastener closed. Ensure that both concealment tabs (one on each extension) are inside the Nomex<sup>®</sup> case.



7.3.7 Closing the snaps.

## 7.3.8

Notice that the CO<sub>2</sub> actuation lanyard forms a loop. The front of the loop has grip beads and the back of the loop is flat webbing with three holes.

Insert the case-flap into the loop of the lanyard so the beads are located on top of the case flap.

Align the three holes on the backside of the lanyard loop with the three snap sockets on the underside of the case flap. Secure the case flap to the snap studs on the front of the case.

Ensure that the holes in the lanyard are around the snap sockets and the lanyard is secured between the Nomex<sup>®</sup> case and the case flap.



7.3.8 Closing the handle.

## 8. Annual Inspection

An inspection should be performed annually to ensure the flotation collar will perform when needed. It is the responsibility of qualified personnel to perform and log this inspection. The inspection can also be performed at the manufacturer. If damage is found during an inspection, the vest must be grounded until repaired. Repairs are limited to replacement of snaps and inflator replacement. All other repairs must be completed at the manufacturer. A functional test should be performed every third year. If a functional test is required, skip to section 9.

The replacement equipment is:

- Replacement CO2 cylinders, 29 gram, 1/2" thread. (if needed)
- Green safety clip, 2 each.

8.1 Remove the flotation collar assembly from the vest and harness.

8.2 Lay the flotation collar flat on the table with the underside down. Spread the outer case open and completely lay out the bladder.

8.3 Perform leak test by connecting a single source of pressurized air to both bladder chambers and the bladder shall be inflated to 2.0 +/- 0.1 PSI using the oral inflation tubes.

8.4 After a minimum of 4 hours. Check pressure. Should not lose more than .4 PSI.



**CAUTION:** If pressure drops more than .4 PSI, completely submerge the flotation collar in water to determine where leakage is occurring. If leakage occurs around inflator, replace inflator and gaskets and perform leak test again. If no determination can be made or bladder is leaking, return to manufacturer for repair.

8.5 Remove trapped air by unlocking oral tube valve and depressing them. A small electric vacuum pump used with the bladder evacuation hose adapter with dual hole (P/N: AMTC-M2026) may be used to aid in removal of the trapped air.

**NOTE:** It is important that all the trapped air be removed to aid in the repack of the bladder assembly and to provide for a compact and low profile collar.

8.6 Lock the oral inflation tube in the closed and locked position.

8.7 Visually inspect the case front and back, inflatable bladder, handle, attachment straps, snaps and components of the flotation collar.

8.8 Remove CO2 cylinders and weigh. If functional is performed, discard and replace.

8.9 Ensure the actuator lever is in the up-and armed position. Install green safety clips on the actuator as shown.

8.10 Install two CO2 cylinders (29 gram. 1/2" thread). Hand tighten the cylinder (avoid over tightening).

8.11 Proceed to section 7.2

## 9. Functional Inspection

A functional inspection should be performed every third year to ensure the flotation collar will perform when needed. It is the responsibility of the ALSE shop to perform and log this inspection. The inspection can also be performed at the manufacturer. If damage is found during an inspection, the vest must be grounded until repaired. Repairs are limited to replacement of snaps and inflator replacement, All other repairs must be completed at the manufacture. Functional inspection is as follows:

9.1 A functional can be performed with an individual wearing the vest with LPU-40 attached or on a table.

9.2 Pull the handle of the LPU-40 away from the bladder to inflate the flotation collar.

**NOTE:** The LPU-40 should inflate fully within 10 seconds.

9.3 Adjust pressure to 2.0 +/- 0.1 PSI. Perform leakage test. Bladder should not loose more than .4 PSI in four hours.



**CAUTION:** If pressure drops more than .4 PSI, completely submerge the flotation collar in water to determine where leakage is occurring. If leakage occurs around inflator, replace inflator and gaskets and perform leak test again. If no determination can be made or bladder is leaking, return to manufacturer for repair.

9.4 Remove the flotation collar from the vest if applicable.

9.5 Return to section 7.1.6 and complete.

## Appendix A. LPU-40 Flotation Bladder Nomenclature

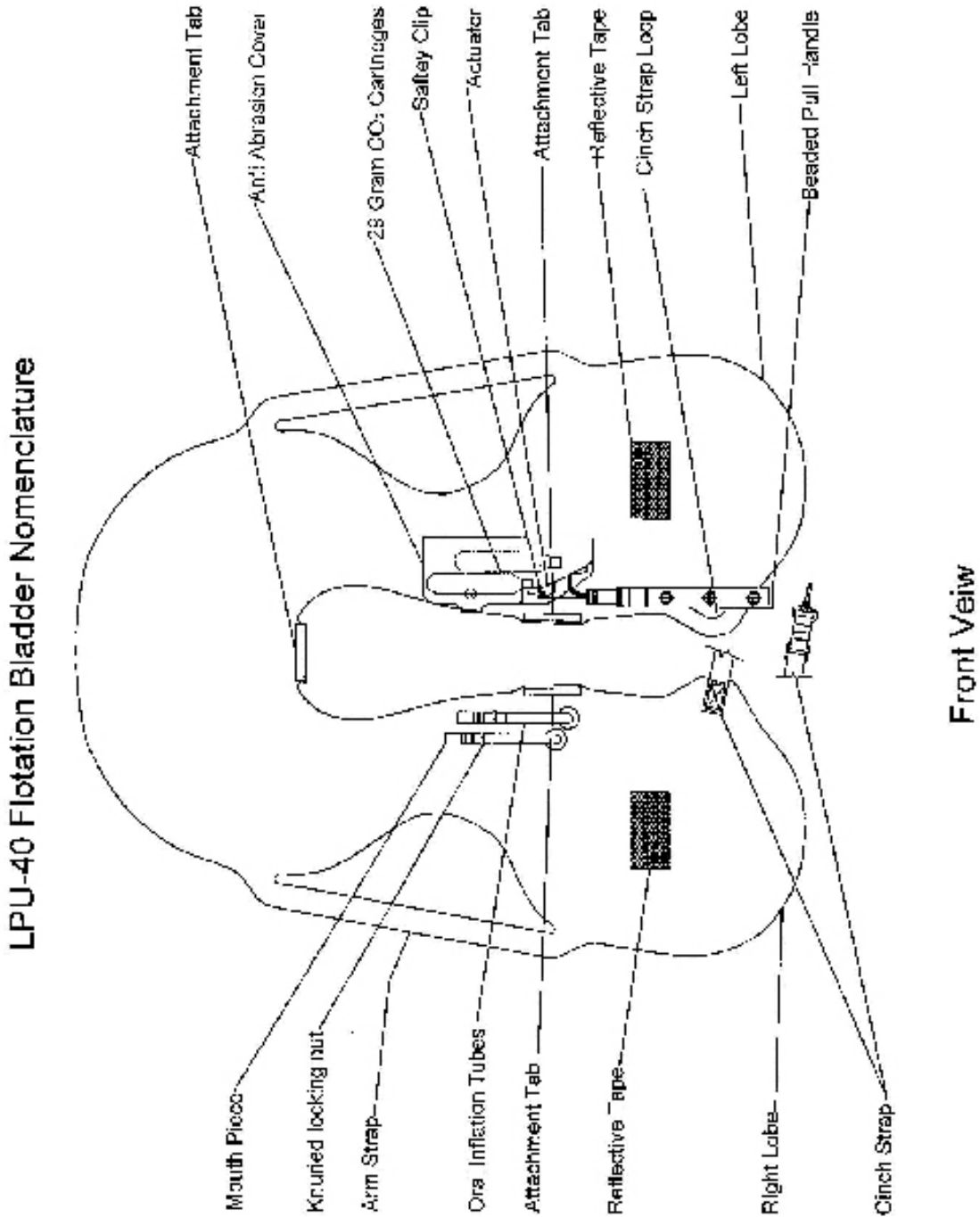

## Appendix B. LPU-40 Casing Nomenclature

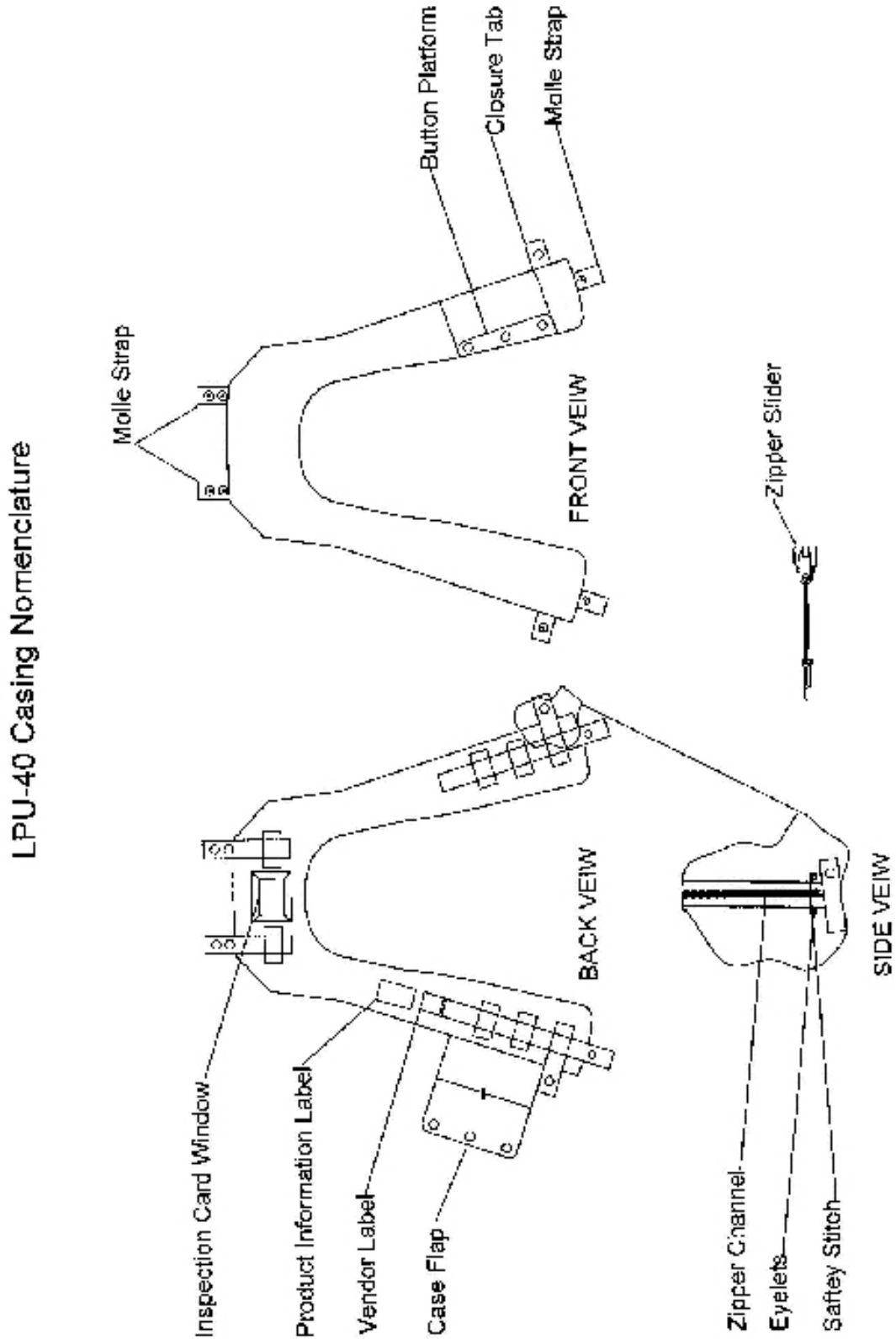

## Appendix C. Bladder Evacuation Attachment Nomenclature

### Bladder Evacuation Attachment Nomenclature

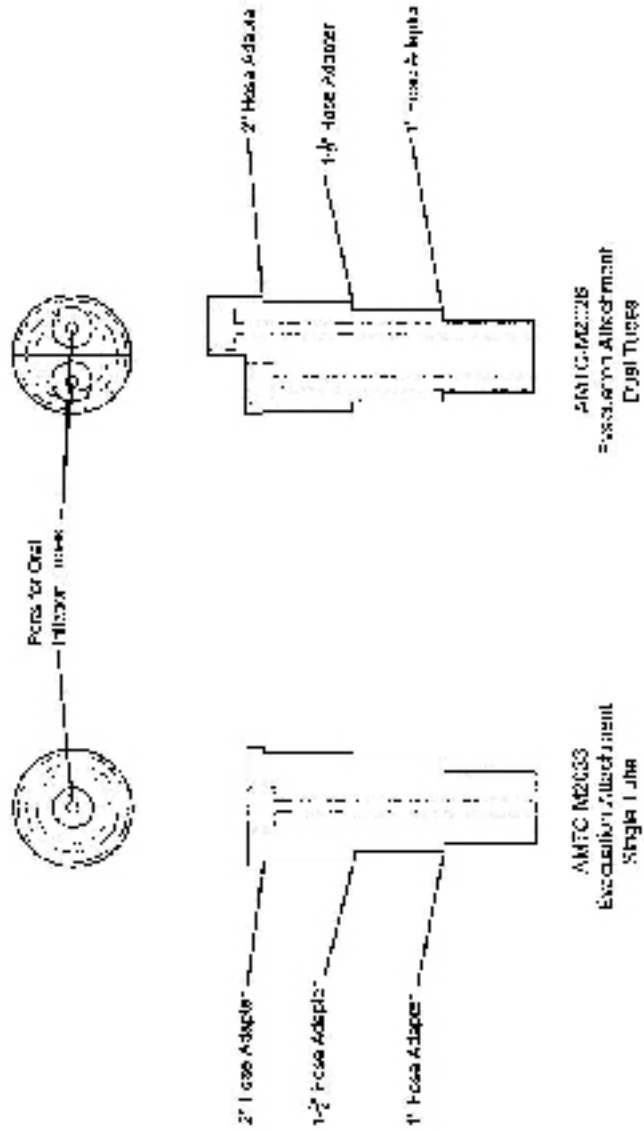

### Appendix D. LPU-40 Bladder Folding Diagram

LPU-40 Bladder Folding Diagram

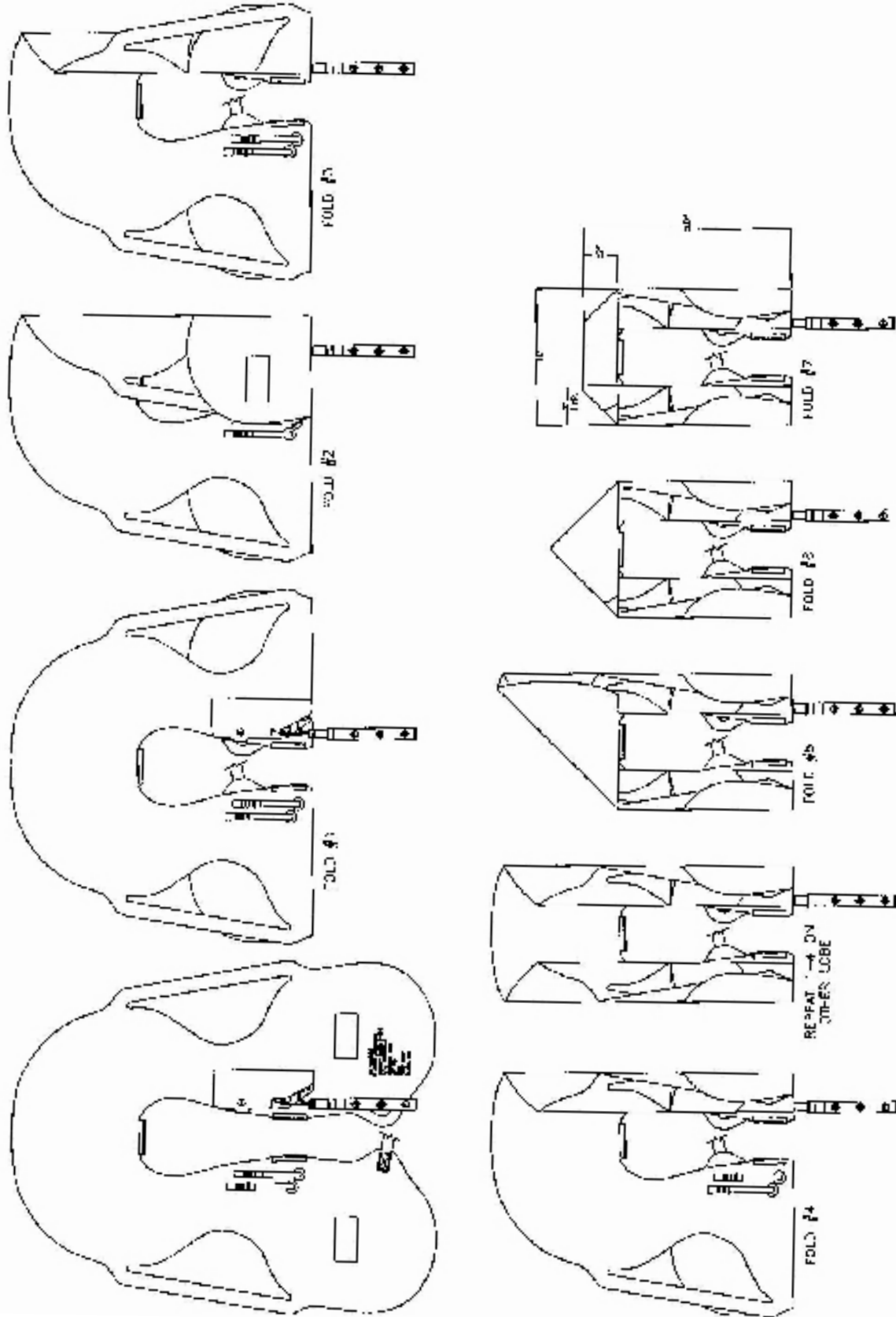

## Appendix E. LPU-40 Folding Cinch Strap Diagram

### LPU-40 Folding Cinch Strap Diagram

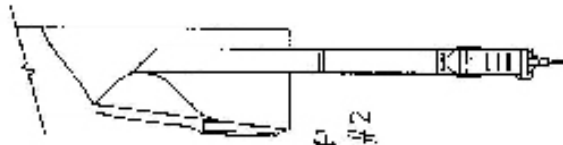

STRAP  
FOLD #2

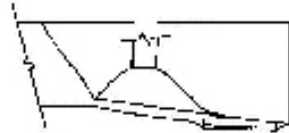

STRAP  
FOLD #1

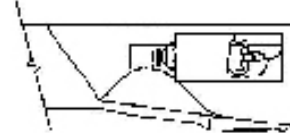

STRAP  
FOLD #4

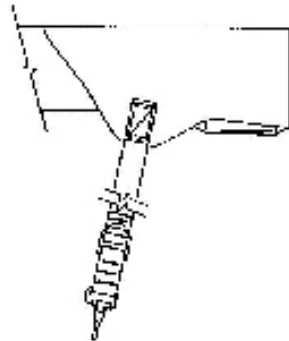

STRAP  
FOLD #3

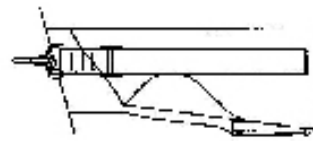

**Appendix F. LPU-40 Spare Parts List**

LPU-40 Spare Parts List	
Item	Part Number
Locking Clip, Safety	8454AMA
Lower Gasket, Actuator	AMTC-R2038
Upper Gasket, Actuator	AMTC-R2039
Cap Nut, Actuator	AMTC-R2040
Inflator Cartridge, 29 grams	7061032-15
Casing, AW FC	AMTC-R1076-UC
Bladder, AW	AMTC-R1077-HH
Anti-Abrasion Sleeve	AMTC-R1078-HH